

A/S

245.

*[Handwritten signature]*

232.3

78WI

*[Faint handwritten text]*

# **WIND DRIVEN WATER PUMPS**

---

## **Economics, Technology, Current Activities**

LIBRARY KD 4542  
International Reference Center  
for Community Water Supply

**DECEMBER, 1978**

**PREPARED FOR:**

**THE WORLD BANK  
1818 H STREET, N.W.  
WASHINGTON, D.C. U.S.A.**

**BY:**

**STEVE BLAKE  
APPROPRIATE TECHNOLOGY GROUP  
ROUTE 1, BOX 93-A  
OSKALOOSA, KANSAS 66066 U.S.A.**

*[Handwritten]* 2323-78WI-1924

LIBRARY INFORMATION OFFICE  
CENTRE FOR COMMUNITY WATER SUPPLY  
AND SANITATION (INC)  
P.O. Box 93-90, 2509 AD The Hague  
Tel. (070) 814911 ext. 141/142  
RN: ISN 1924  
LO: 232.3 70 WI

LIBRARY ~~KD 4542~~  
International Reference Centre  
for Community Water Supply

The Appropriate Technology Group (Route 1, Box 93-A; Oskaloosa, Kansas 66066 USA; 913-597-5603) was established in 1972 with the single goal of developing wind energy resources in developing countries. To this end, ATG has brought together researchers, engineers, and manufacturers from the United States wind energy industry to develop and improve designs, provide information, and offer consulting services. Our expertise includes both water pumping and electrical generation technologies.

© Appropriate Technology Group, 1978

## CONTENTS

### ANALYSIS

Overview	1
Characteristics	2
Economics	3
Aermotor-type	3
Indigenous	4
Gasoline Engine	5
Conclusions and Recommendations	9
Aermotor-type	9
Indigenous	10

### REVIEW

Aermotor-type windmills	12
Aermotor	13
Dempster	13
Sparco	14
Indigenous windmills (horizontal axis)	15
Polomo	16
SWD, Steering Committee for Wind Energy in Developing Countries	17
Windworks	18
Arusha	18
New Alchemy Institute	19
ITDG, Intermediate Technology Development Group	19
Savonius rotors (horizontal axis)	20
CIAT, Centro Internacional de Agricultura Tropical	21
Brace Research Institute	22
IRRI, International Rice Research Institute	23
Bibliography	24

OVERVIEW

Wind driven water pumping systems, windmills, are some of the oldest machines. Predating Christ, windmills have been developed by many cultures to lift water for livestock, land drainage, irrigation, salt production, and domestic supplies.

The evolution of these various windmill designs reflects the resources, economic development, skills, geography, and water needs of the different cultures and regions. These designs encompass a broad spectrum of technological sophistication.

At one end of this spectrum are the centuries old indigenous windmills such as are still used today in the Mediterranean region and in southeast Asia. These designs use many wood components including bearings, sail cloth and bamboo mat 'blades', and are fabricated and maintained locally.<sup>1</sup>

On the other end of this spectrum are the Aermotor-type windmills developed at the end of the 1800's and available on today's international export market. These windmills played a major role in opening the western frontiers of North America and Australia, and are used extensively today in these areas primarily for watering livestock.<sup>2</sup> These designs are highly evolved and they have proven histories of reliability and effectiveness.

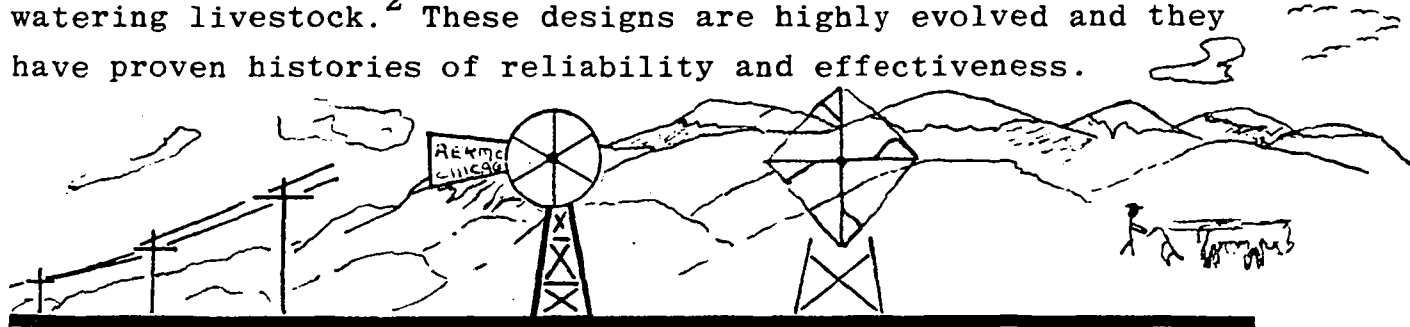

- 
1. For a comprehensive review of indigenous designs see "Practical Applications of Wind Powered Water Pumps" by Marcus M. Sherman; United Nations Economic and Social Commission for Asia and the Pacific, Sala Santitham, Bangkok - 2, Thailand; February, 1977.
  2. The New Mexico University Energy Institute (Las Cruces, NM 88003 USA) reports 15,000 windmills in the State, in the arid southwest.

CHARACTERISTICS

The following is a summary of characteristics typical of Aermotor-type and indigenous windmills:

<u>AERMOTOR-TYPE</u>	<u>INDIGENOUS</u>
High capital cost	Low capital cost
Long life, typically around 30 years	Shorter life, 5 - 15 years
Low maintainance	Higher maintainance
High heads, up to 1,000' available	Lower heads
Manufacture requires mature steel fabrication processes	Windmill design is defined by the available manufacturing capabilities of a region
Highly evolved, engineered designs	Designs typically lack engineering
Available on international export market	Regionally available

ECONOMICS

Aermotor-type windmills were the unchallenged rural water systems in the United States until the Rural Electrification Act of 1937 provided low interest capital for centrally distributed electrical networks. Consequently, low cost electric motor-pump water systems soon replaced windmills.

The following graph shows the current cost of delivered water (as kw-hrs of work) from Aermotor-type windmills:

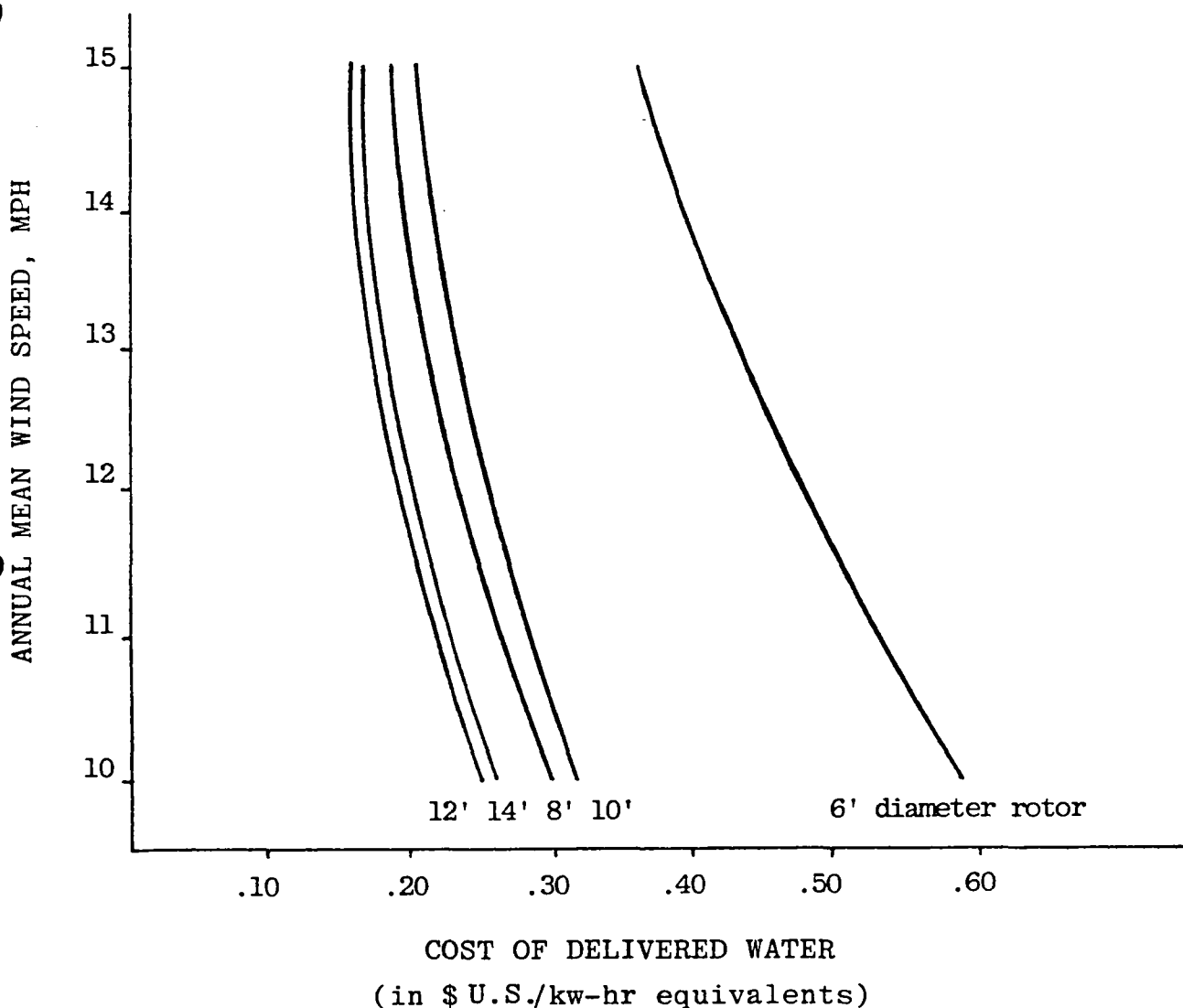

The preceding graph was derived from the following data and procedures:

SPECIFICATIONS	COSTS, \$US	PERFORMANCE			
		Output, usg/hr Cp <sup>6</sup> Energy <sup>7</sup> Energy cost <sup>8</sup>	Mean Annual Wind Speed		
Rotor diameter Head Life Pump	Equipment <sup>4</sup> Installation O&M @ 1%/year Interest <sup>5</sup>		10 mph	12 mph	15 mph
6' 95' 30 years 2" dia.	\$1,630 600 669 1,698		.81 .08 6,300 58¢	104 .06 8,100 46¢	130 .05 10,200 36¢
8' 135' 30 years 2" dia.	1,855 600 736 1,869		121 .10 13,350 30¢	156 .08 17,340 23¢	195 .06 21,540 18¢
10' 210' 30 years 2" dia.	2,580 700 984 2,498		99 .08 17,100 32¢	127 .06 20,050 27¢	159 .05 27,600 20¢
12' 304' 30 years 2" dia.	3,950 800 1,425 3,617		128 .10 31,500 25¢	165 .08 41,100 19¢	206 .06 49,950 16¢
14' 455' 30 years 2" dia.	5,570 900 1,941 4,927		109 .10 41,250 26¢	141 .08 52,800 20¢	176 .05 66,000 16¢

3. Based on information provided by Aermotor-Braden Industries, Inc., Conway, Arkansas 72032 USA and Dempster Industries, P.O. Box 848, Beatrice, Nebraska 68310 USA.

4. Equipment includes windmill, 40' tower, sucker rod, and pump. Well casing, storage tank, and freight not included.

5. Interest computed at 10% compounded monthly, amortized over 10 years.

6. Cp, Co-efficient of performance =  $\frac{\text{Windstream energy across rotor}}{\text{Delivered energy as pumped water}}$

To analyse the cost/benefits of indigenous windmills, three designs which have been introduced and manufactured in the third world by foreign professional development workers will be considered. They are all assumed to have 10 year lives, while in fact their actual working life is unknown.

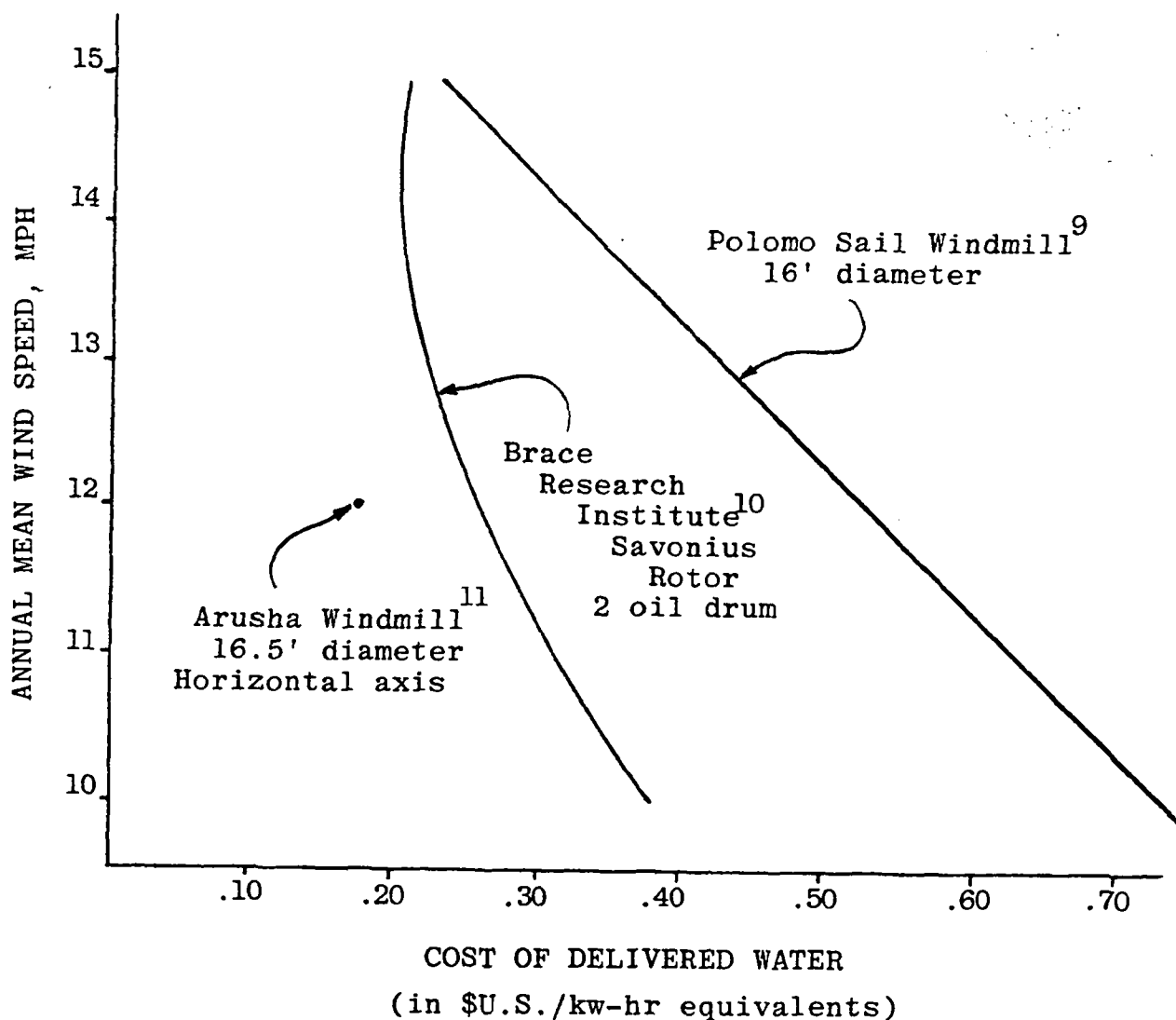

- 
7. Energy delivered, kw-hrs =  $\frac{\text{water pumped}(\#) \times \text{head}(\text{ft})}{60 \times 33,000} \times .746 \times 8,760\text{hrs} \times \text{life}(\text{yrs})$
8. Energy cost = (system cost / energy delivered) x electric motor efficiency of .8
9. Data from Food from Windmills by Peter Fraenkel, Intermediate Technology Publications, LTD.; 9 King Street; London WC2E 8HN United Kingdom.
10. Data from How to Construct a Cheap Wind Machine for Pumping Water, Brace Research Institute, MacDonald College, Ste. Anne de Belevue 800, Quebec, Canada.



The preceding graph was derived from the following data.<sup>9,10,11</sup>

SPECIFICATIONS	COSTS, \$US	PERFORMANCE			
		Output, usg/hr Cp <sup>6</sup> Energy <sup>7</sup> Energy cost <sup>8</sup>	Mean Annual Wind Speed		
Name Rotor diameter Head Life Pump	Equipment Installation O&M @ 2%/year Interest <sup>5</sup>		10 mph	12 mph	15 mph
Polomo SWM 16' 9' 10 years 2" dia. cyl.	\$350 50 70 328		450 .005 1,100 73¢	600 .005 1,450 55¢	1,440 .006 3,530 23¢
Brace S-rotor 18ft. <sup>2</sup> area 10' 10 years 7" diaphragm	140 50 28 134		330 .06 911 38¢	450 .05 1,370 26¢	600 .04 1,647 21¢
Arusha Mill 16.5' 180' 10 years 2 dia. cyl.	2,120 900 424 2,102			600 .10 29,738 18¢	

11. Data obtained from "VITA News", August 1978, page 6; also from Ujuzi Leo Industries, P.O. Box 764, Arusha, Tanzania.

Small gasoline or diesel engine driven pumps are considered options to windmills in certain water supply applications. They are also used sometimes to supplement windmills during periods of prolonged calm wind.

Compared with windmills, the primary advantage of these engine-pumps is low capital cost while high energy and maintenance costs and short life are distinct disadvantages..

Low head and high head applications require different engine-pump configurations both of which are compared with windmills in the following examples:

Low Head Application - Head: 90' (5' suction),  
Demand: 50,000 - 100,000 us gallons per month

	<u>WINDMILL</u>	<u>GASOLINE ENGINE</u> <sup>12</sup>
Manufacturer, type	Aermotor, 6' dia., 40' tower	Briggs & Stratton, 4 hp, 3600 rpm, Model 80200, air-cooled
Pump	Positive displacement, single action 2" diameter	Centrifugal, suction
System life	30 years	100 - 500 hours
Pumping capacity (at mean wind speeds)	10 mph - 80 g/hr (21x10 <sup>6</sup> g/30yrs) 12 mph - 104 g/hr (26x10 <sup>6</sup> g/30yrs) 15 mph - 130 g/hr (34x10 <sup>6</sup> g/30yrs)	1,200 g/hr 600,000 g/500 hrs
Lifetime system cost	Equipment \$1,630 Install 600 O&M, 1%/yr 669 Interest <sup>5</sup> <u>1,698</u> Total 4,597	Engine 115 Pump 85 O&M 30 Interest <sup>5</sup> , 1yr 20 Fuel, 0.25 g/hr @ .625 load; 500 hrs; \$1/g <u>125</u> Total 375
Cost per 1,000 gallons of water delivered	\$0.22 US (10 mph) 0.18 US (12 mph) 0.14 US (15 mph)	\$0.63 US

High Head Application - Head: 300'

Demand: 90,000 - 150,000 us gallons per month

	<u>WINDMILL</u>	<u>GASOLINE ENGINE</u>
Manufacturer, type	Aermotor, 12' dia., 40' tower	Briggs & Stratton, 4 hp, 3600 rpm, Model 80200, air-cooled
Pump	Positive displacement, single action, 2" diameter	Dempster Model 76 reciprocating pump coupled to a positive displacement, single action, 2" dia. cylinder
System life	30 years	100 - 500 hours
Pumping capacity (at mean wind speeds)	10 mph - 128 g/hr (34x10 <sup>6</sup> g/30yrs) 12 mph - 165 g/hr (43x10 <sup>6</sup> g/30yrs) 15 mph - 206 g/hr (54x10 <sup>6</sup> g/30yrs)	220 g/hr 110,000 g/500 hrs
Lifetime system cost	Equipment \$3,950 Install 800 O&M, 1%/yr 1,425 Interest <sup>5</sup> 3,617 <u>          3,617</u> Total 9,892	Engine 115 Pump 750 O&M 30 Interest <sup>5</sup> , 1yr 87 Fuel, 0.25 g/hr @ .625 load; 500 hrs: \$1/g 125 Total 1,107
Cost per 1,000 gallons of water delivered	\$0.29 US (10 mph) 0.23 US (12 mph) 0.18 US (15 mph)	\$0.90 US

As the size of gasoline or diesel engine-pumps increases, their cost/benefits improved markedly due largely to their longer life which results from water cooling. Such large engine-pumps are widely used in large water demand applications.

In low demand applications where intermittent supply is tolerable or smoothed out with storage and/or a small engine-pump, and where capital is available, the cost/benefits of windmills are more favorable than small gasoline engine-pumps.

---

12. Information from Briggs & Stratton, Milwaukee, Wisconsin and from Mathews Hardware Store, Perry, Kansas USA, a Briggs service center.

## CONCLUSIONS AND RECOMMENDATIONS

### Aermotor-type Windmills

Aermotor-type windmills are today the most cost effective, small demand water pumping systems where centrally distributed electricity is unavailable and annual mean wind speeds exceed 8 mph. Where centrally distributed electricity is available at an average projected cost over 30 years of \$0.14 (US) (in regions of 15 mph mean annual wind speeds) to \$0.24 (10 mph regions) per kilowatt-hour, Aermotor-type windmills are cost competitive.

Capital availability is the primary obstacle to using Aermotor-type windmills. Finance strategies for rural development should consider windmills where the economic posture of a region justifies this level of investment and centrally distributed electricity is not available or imminent.

Aermotor-type windmill designs may be copied for local fabrication as patents on these have expired. The fabrication process requires metal casting, turning, bearings, galvanizing, and gear cutting. These designs have been successfully modified to circumvent unavailable processes and/or materials.<sup>13</sup>

Development organizations should be encouraged to sponsor the development of "windmill production packages". These packages would include drawings, material specifications and options, detail of fabrication processes, and available on-site technical assistance. These packages would then be made available to potential fabricators-users world-wide (see Indigenous packages).

Today, tens of thousands of good, used Aermotor-type windmills stand idle in North America in the wake of the spread of centrally distributed electrical networks. Complete systems can typically be purchased for \$100 - \$400 (US). Consideration should be given to recovering and using this equipment.

## Indigenous Windmills

Today in numerous situations world-wide, low-cost indigenous windmill designs fabricated with local skills and materials are providing water which otherwise would be drawn either by people or animals, or not at all. The situations are characterized by a low level of economic development and a lack of capital financing structures.

These indigenous windmill designs can have world-wide impact on the development and upgrading of water supplies. However, the transfer and use of this technology has not occurred because potential fabricators-users are unaware of their potential. Where "outside" development workers have introduced indigenous windmills, they have often been adopted, and the accompanying increase in water supplies have increased the quality of life.<sup>14</sup>

The availability of quality information will do the most to further the use of this technology. First, information which documents existing designs in terms of required materials, fabrication processes, and the engineering parameters of the systems, subsystems, and components needs to be assembled. Then this information should be assessed and upgraded through state-of-the-art wind systems engineering.<sup>15</sup> Hybrid designs should then be evolved which synthesize this knowledge in terms of specifically available materials, skills, fabrication processes, and other relevant parameters.

Then complete "windmill production packages" should be developed which would include drawings, material specifications and options, and on-site technical assistance. The availability of these "packages" should then be made known to potential fabricators-users through national and local government channels, the international development community, and other information dissemination channels, including "How-to-build" workshops for international development workers.

At the point of delivery to a fabricator-user, the "package" must be sold to insure maximum commitment and to maintain integrity.

Once sold and in production, the above processes should then become an iterative learning process. What works? What does not? Why?

The above processes are already underway today through the efforts of various development organizations. The work of several of these groups is reviewed on the following pages:

- 
13. Marcus Sherman (P.O. Box 458, Hyannis Port, MA 02647 USA) reports of a manufacturer in Bangkok, Thailand who has modified an Aermotor-type design to circumvent gears and an oil bath; Ron Alward (NCAT, Box 3838, Butte, MT USA 59701) reports of a group of Mennonites in Paraguay that is manufacturing a modified Aermotor-type design locally.
  14. The experiences related by Peter Fraenkel (see footnote 9) and by James Spain in Columbia (see following pages) are two examples of the successful introduction of this equipment.
  15. There has been a resurgence of activity in wind system design in the United States since 1973 which is reflected in part by the U.S. Department of Energy's 1979 budget of \$60m for wind energy resource development. Much computer software pertaining to wind system analysis, design, and engineering has been developed by various companies and can be directly applied to indigenous windmill design and fabrication processes.

# AERMOTOR-TYPE WINDMILLS

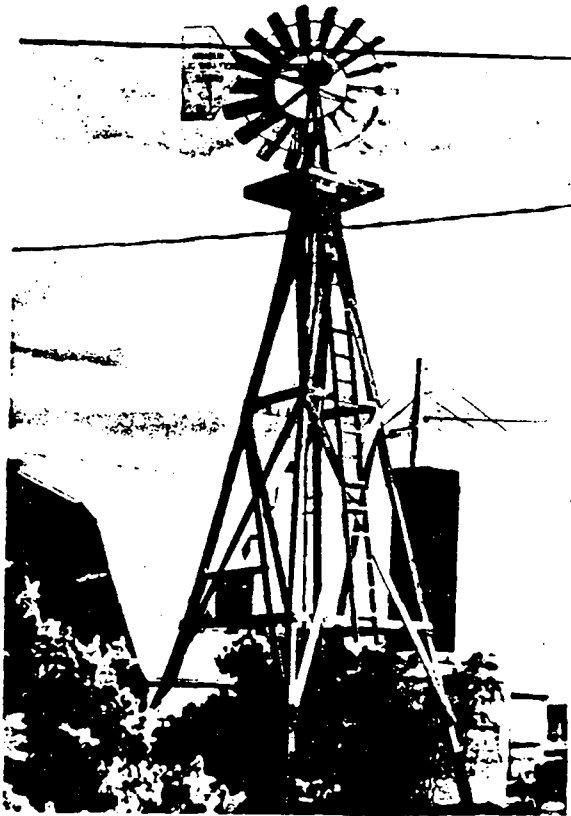

ALBERT MAHR FARM, 1978  
Lorenzo, Nebraska USA

The tower, rather than the standard galvanized steel angle iron, was built from 4"x4" wood by Albert's father in 1911. Rainfall: 17"/year.

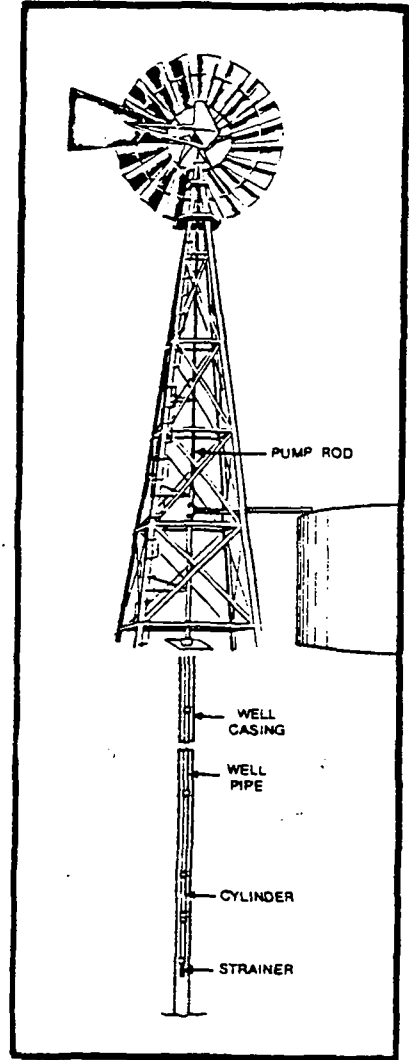

TYPICAL WINDMILL  
INSTALLATION ON A  
DRILLED WELL

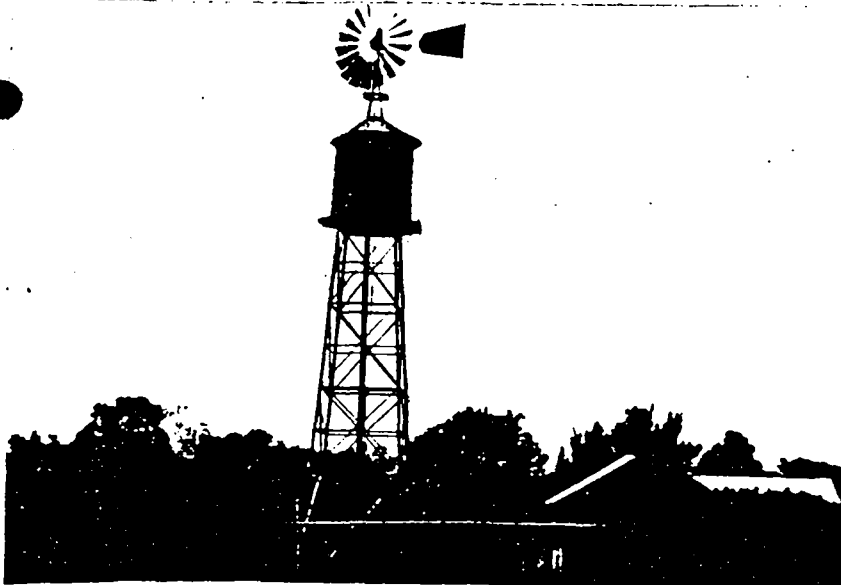

This windmill with water storage integrated into the tower provides water on demand and under pressure to the adjacent building.

AVERAGE WATER NEEDS	
Type	Gallons
Milking cow, per day	35
Dry cow or steer, per day	15
Horse, per day	12
Hog, per day	4
Sheep, per day	2
Chickens, per 100, per day	6
Bath tub, each filling	35
Shower, each time used	25 - 60
Lavatory, each time used	1 - 2
Flush toilet, each filling	2 - 7
Kitchen sink, per day	20
Automatic washer, each filling	30 - 50
Dishwasher	10 - 20
Water Softener	up to 150
1/4-inch hose, per hour	300
Other uses, per person per day	25

from Aermotor Co.

Aermotor has produced more windmills than any manufacturer in the U.S. First introduced in 1888, they are now manufactured in Argentina.

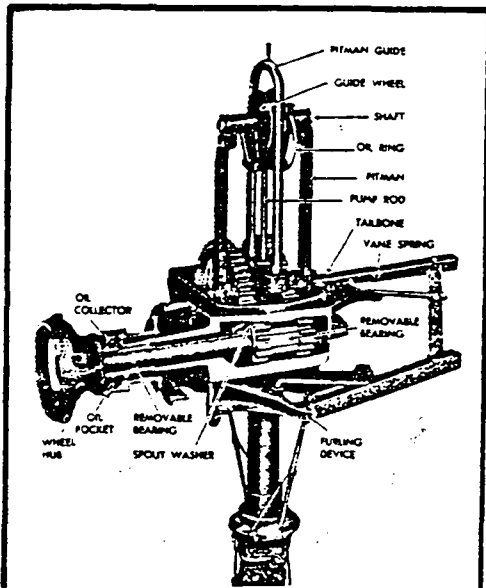

**THE OILING SYSTEM**

The gears and bearings of the Aermotor are constantly flooded with oil from the supply in the gear case. The large oil ring supported by the pump rod yoke picks up oil from one of the gears on the down stroke and carries it to the cross shaft, thus keeping all of the upper bearings automatically lubricated.

Diameter of Cylinder (Inches)	AERMOTOR PUMPING CAPACITY							
	Capacity per Hour, Gallons		Total Elevation in Feet					
			SIZE OF AERMOTOR					
	6 Ft	8-16 Ft	6 Ft	8 Ft	10 Ft	12 Ft	14 Ft	16 Ft
1 1/4	105	150	130	185	280	420	600	1,000
1 1/2	123	180	120	175	260	390	560	920
2	130	190	95	140	215	320	460	750
2 1/4	180	280	77	112	170	250	360	590
2 1/2	225	325	65	94	140	210	300	490
2 3/4	265	385	56	80	120	180	260	425
3	320	470	47	68	100	155	220	360
3 1/4	—	550	—	—	88	130	185	305
3 1/2	440	640	35	50	76	115	160	265
3 3/4	—	730	—	—	65	98	143	230
4	570	830	27	39	58	86	125	200
4 1/4	—	940	—	—	51	76	110	180
4 1/2	725	1,050	21	30	46	68	98	160
4 3/4	—	1,170	—	—	—	61	88	140
5	900	1,300	17	25	37	55	80	130
5 1/4	—	1,700	—	—	—	40	60	100
6	—	1,875	—	17	25	38	55	85
7	—	2,550	—	—	19	28	41	65
8	—	3,300	—	—	14	22	31	50

Capacities shown in the above table are approximate, based on the mill set on the long stroke, operating in a 15 to 20 mile-an-hour wind. The short stroke increases elevation by one-third and reduces pumping capacity one-fourth.

AERMOTOR WINDMILL SPECIFICATIONS				
MODEL 702*	MILL SIZE (WHEEL DIA.) (Feet)	STROKE (Inches)	NO. OF SAILS	SHIPPING WEIGHT (Pounds)
X	6	5 1/2 & 3	18	210
A	8	8 & 6	18	355
B	10	10 & 7 1/2	18	645
D	12	12 & 9	18	1090
E	14	14 & 10	18	1695
F	16	16 & 12	18	2450

\*Model 702 windmills were introduced in 1933.

**AERMOTOR WATER SYSTEMS**  
**BRADEN INDUSTRIES, INC.**  
 CONWAY, ARKANSAS 72032 USA  
 1-501-329-2969

Model No.	Size (Inch)	Stroke (Inch)	No. of Arms	No. of Sails	Stroke, In.	No. of Fans	Shipping Weight (Lbs.)
12	6	4 to 1	5	5	5	15	261
12A	8	3 1/2 to 1	5	5	5 1/2 and 7 1/2	15	373
12	10	3 to 1	8	8	5 1/2 and 7 1/2	24	510
12	12	3 to 1	6	6	8, 10, and 12	18	1178
12B	14	3 to 1	6	6	8, 10, and 12	18	1450

**BACK GEARED WINDMILLS**

**PUMPING CAPACITY**

These capacities are based on a 15-mile per hour wind for small mills and 18 to 20 miles per hour wind for larger mills. Capacities are based on longest stroke of Dempster mills. If short stroke used, capacities will be reduced in proportion to length stroke used.

Cylinder Size	6 Ft.		8 Ft.		10 Ft.		12 Ft.		14 Ft.	
	Stroke	G.P.H.	Stroke	G.P.H.	Stroke	G.P.H.	Stroke	G.P.H.	Stroke	G.P.H.
1 1/4	120	115	172	173	256	140	388	180	530	159
2	95	130	135	195	210	159	304	206	455	176
2 1/4	75	165	107	248	165	202	240	260	360	322
2 1/2	62	206	89	304	137	248	200	322	300	276
2 3/4	54	248	77	370	119	300	173	390	260	334
3	45	294	65	440	102	357	147	463	220	396
3 1/4	39	348	55	565	86	418	125	544	187	465
3 1/2	34	400	48	600	75	487	108	630	162	540
3 3/4	29	457	42	688	65	558	94	724	142	620
4	26	522	37	780	57	635	83	822	124	705

If the wind velocity be increased or decreased, the pumping capacity of the windmill will also be increased or decreased. Capacities will be reduced approximately as follows: if wind velocity is less than 15 miles per hour, 12 mile per hour wind, capacity reduced approximately 20%. 10 mile per hour wind, capacity reduced approximately 36%.

**WHEEL CAN'T COME LOOSE**

Wheel spider is made with a split hub which clamps around the wheel shaft. A heavy steel heat-treated bolt clamps the spider securely to the shaft - making it impossible for the wheel to come loose.

**SCIENTIFICALLY DESIGNED FANS** utilize the full power of the wind. Fans are made from heavy gauge steel and securely fastened to circles to keep proper curvature and position. They cannot spring out of shape. Thoroughly galvanized wheel is not affected by atmospheric conditions.

**BALL BEARING TURNABLE** allows quick response. Ball races are semi-steel, specially hardened and finished smooth to permit balls to roll freely. Enough balls are used to withstand five times the load they carry.

**VANE WON'T SAG OR BUCKLE**

Made of angle steel, completely galvanized and sturdily braced, the vane stem is built to last for years.

**MACHINE-CUT EQUALIZING GEARS** work independently of each other on a steel bearing. Gears run in an oil bath. Machine cut gears and pinions give perfect bearing surface over full width of the cog - each gear carries its full part of the load.

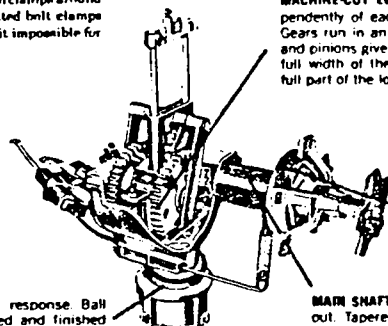

**INTERNAL EXPANDING BRAKE** combines best features of both the steel band brake and cast shoe brake. Has heavy cast shoe and special steel brake lining.

**MAIN SHAFT ASSEMBLY** should never wear out. Tapered roller bearings absorb the thrust and wear of the shaft. Provides quicker, smoother pumping starts.

Dempster has manufactured windmills for over 40 years and is the 'other' windmill company in the U.S.

**DEMPSTER INDUSTRIES**  
 P.O. BOX 848  
 BEATRICE, NEBRASKA 68310 USA  
 1-402-223-4026



The Sparco is a new arrival on the windmill scene. Its low cost is quite welcomed and it is capable of handling low head water supply problems. The manufacturer says there are over 30,000 installations to date, its life span is unknown. The following information is provided by the manufacturer:

- Ball bearings on crankshaft
- 50" rotor with self-feathering blades
- Will pump 30 gallons per hour in 7 mph wind speeds or greater  
(The head is not specified.)
- Semi-annual greasing
- Installation by one person in 30 minutes
- \$345 (US) with diaphragm pump
- \$395 (US) with piston pump capable of 33' lift (46' to discharge point)

For additional information, contact the exclusive North American distributor:

Enertech Corporation  
P.O. Box 420  
Norwich, VT 05055 USA  
1-802-649-1145

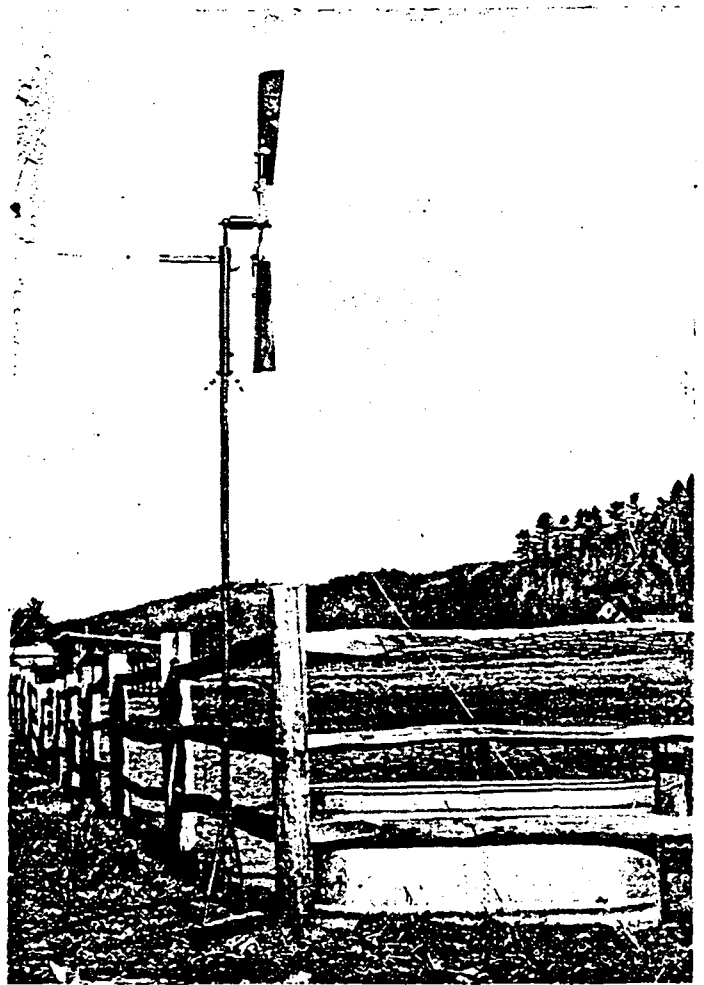

# INDIGENOUS WINDMILLS

Of the indigenous windmills, the sail windmill design is the most widely used today and is integral to agriculture throughout the Mediterranean and southeast Asia.



Hundreds of sail windmills on the Island of Crete

SAIL WINDMILL

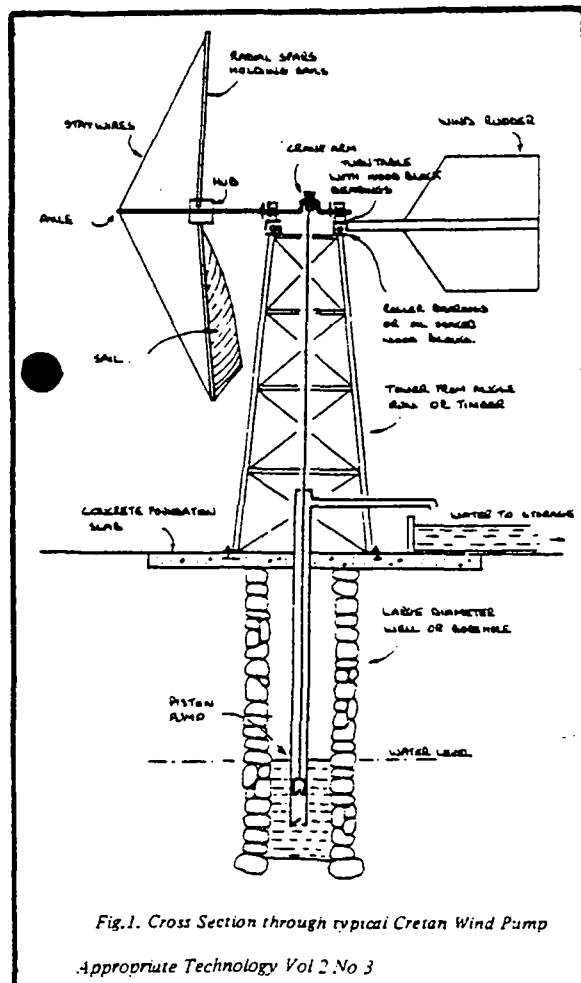
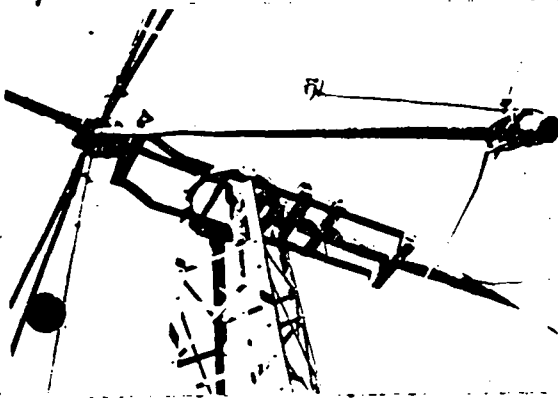
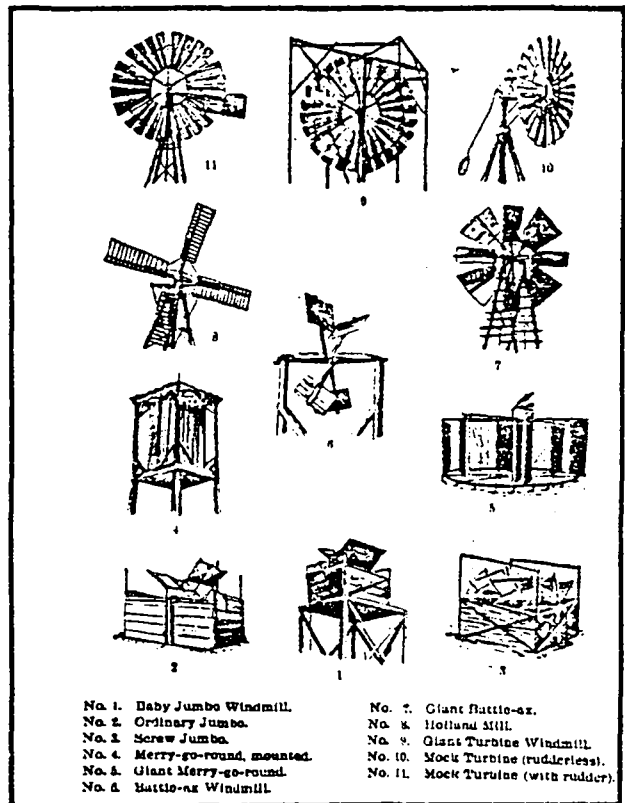

Fig.1. Cross Section through typical Cretan Wind Pump  
Appropriate Technology Vol 2 No 3



- No. 1. Baby Jumbo Windmill.
- No. 2. Ordinary Jumbo.
- No. 3. Screw Jumbo.
- No. 4. Merry-go-round, mounted.
- No. 5. Giant Merry-go-round.
- No. 6. Battice-as Windmill.
- No. 7. Giant Battice-as.
- No. 8. Holland Mill.
- No. 9. Giant Turbine Windmill.
- No. 10. Mock Turbine (rudderless).
- No. 11. Mock Turbine (with rudder).

Many U.S. farmers and ranchers built their windmills in the early 1900's.

FROM: *HOMEMADE WINDMILLS OF NEBRASKA* by Erwin Hinckley Barbour; University of Nebraska Ag. Bull. 59, 1899.

The Polomo sail windmill was copied from traditional Mediterranean designs and adapted to pumping water for irrigation from the Omo River in Ethiopia by Mr. E.O. Pollock and the Rev. J.R. Swart of the Omo American Mission. The design is built entirely in Ethiopia and is used by native Geleb farmers who purchase the windmills for \$5.00 (Eth.) per year from the Mission. As of 1975 there were 19 of these windmills in use over a 10 km stretch of the Omo. These windmills enabled the Geleb to obtain three crops per year from their land as opposed to the traditional single harvest per year and the accompanying prosperity has made the windmills much sought after.

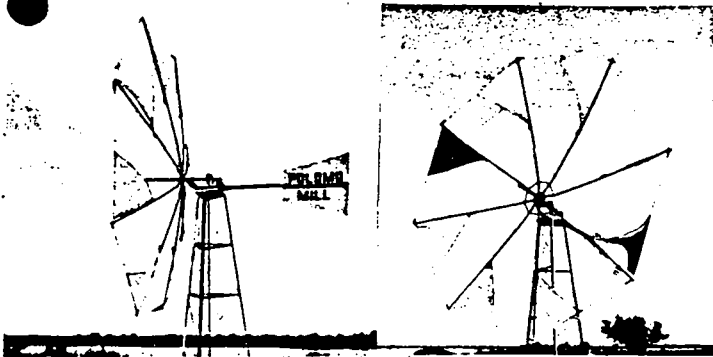

POLOMO SAIL WINDMILL, 16' ROTOR

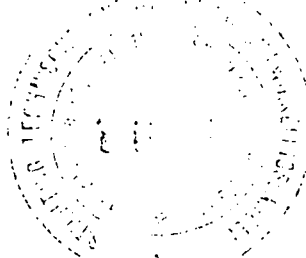
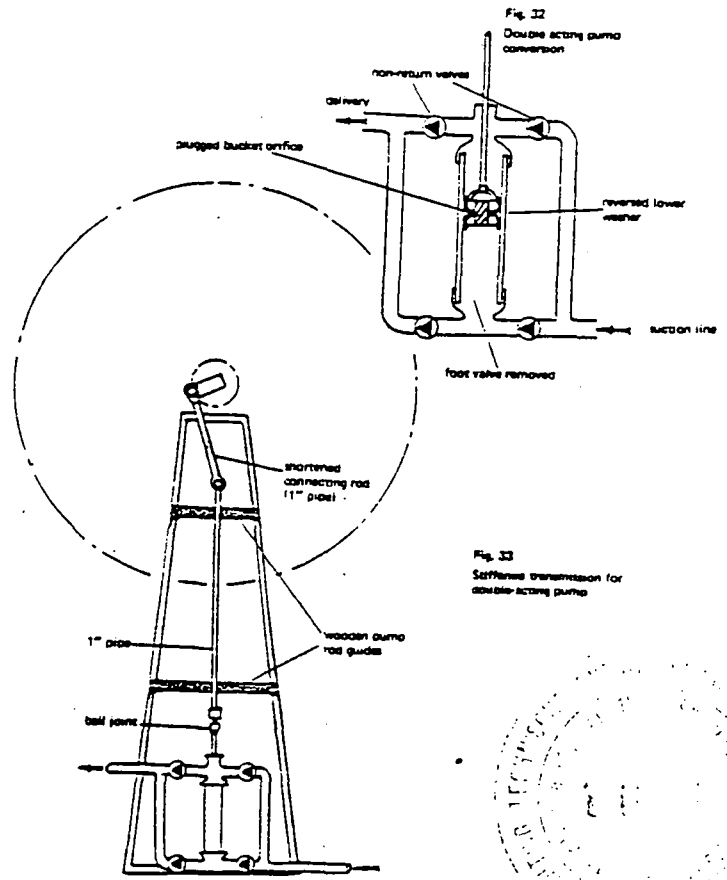

Protecting windmills against high winds is an important design consideration. The Polomo design takes advantage of the farmer's presence to manually control it, and neighborhood habits when he is absent:

"Sails on the traditional Cretan wind sails are generally reefed by rolling them around the arms of the wheel, but this is not a practical means in southern Ethiopia as cloth, being a rare and valuable commodity, is likely to be taken during the night (and sails are taken home at night)."

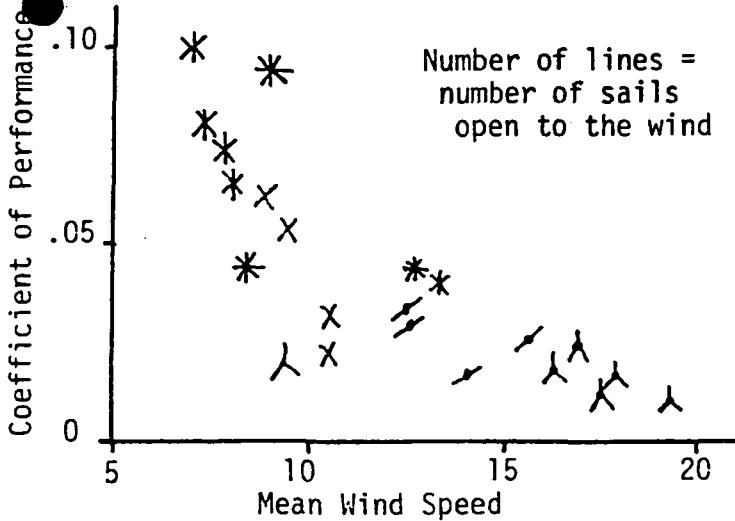

PERFORMANCE OF 14' WINDMILL

FROM: FOOD FROM WINDMILLS  
by Peter Fraenkel, 1975;  
Intermediate Technology  
Publications, LTD.; 9 King  
Street; London WC2E 8HN  
United Kingdom.

SWD, the Steering Committee for Wind Energy in Developing Countries (P.O. Box 85, Amersfoort, The Netherlands) is leading the way in the development of wind energy resources in developing countries. Comprised of three Universities, a group of research scientists, and a group of private engineers, SWD is asking the right questions and is answering them with excellent publications, designs, and hardware.

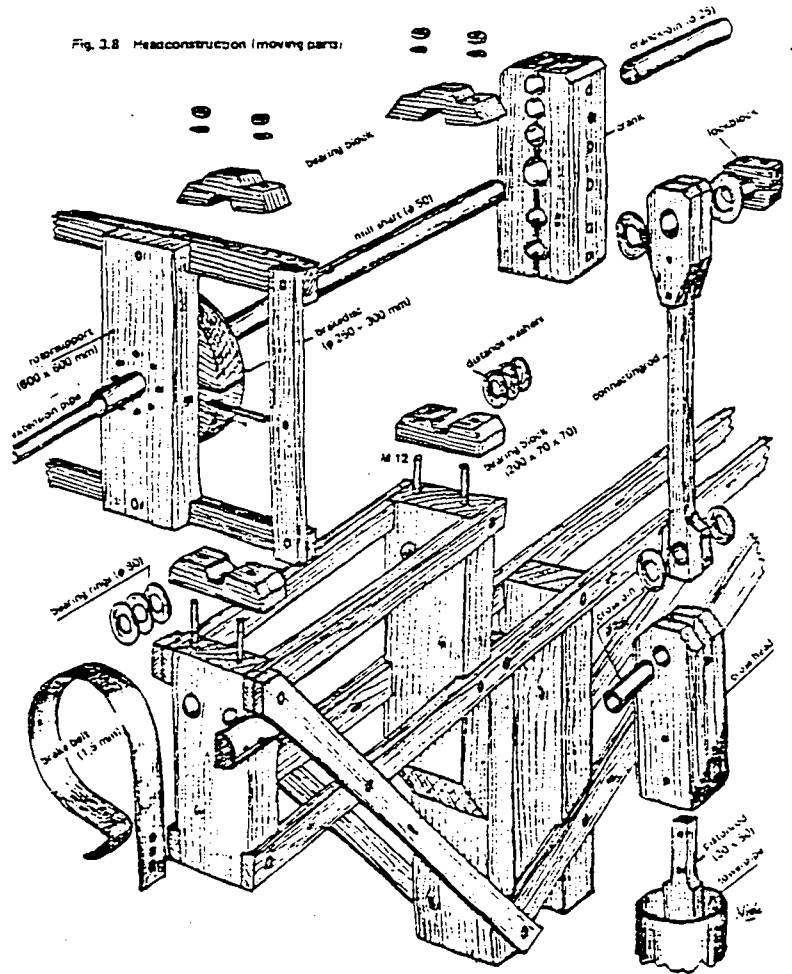
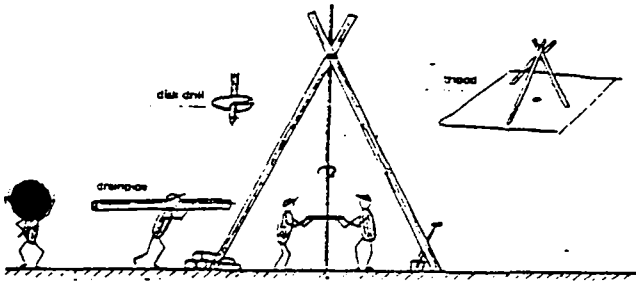
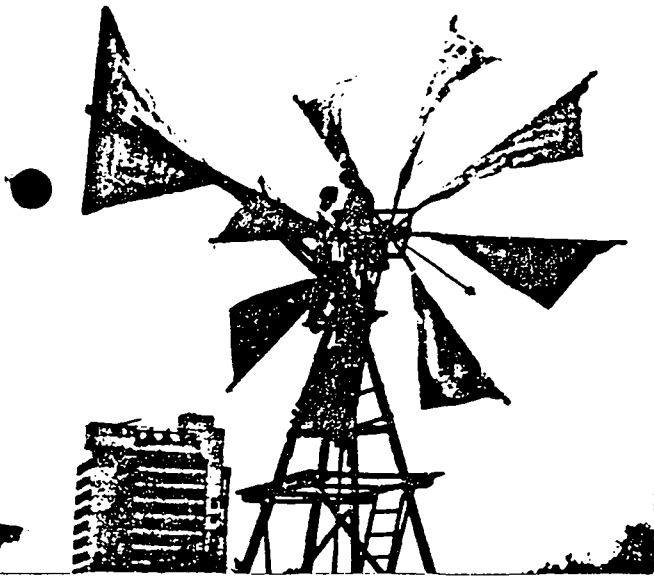

### CONSTRUCTION MANUAL FOR A CRETAN WINDMILL

The manual details a design using mostly wood components. Details for constructing a wood lathe with which to build the windmill are included as well as instructions for drilling and casing a well.

### SWD PUBLICATIONS

"Wind energy utilization in Sri Lanka; potentialities and constraints."

"Literature survey; horizontal axis fast running wind turbines for developing countries."

"Model for cost comparison of windmills with engine pumps."

"Performance characteristics of some sail and steel bladed windrotors."

"Feasibility study of windmills for Water Supply in Mara Region, Tanzania."

"Rotor design for Horizontal Axis Windmills."

"WIND AND SUN COMPENDIUM" is a newsletter for the development of wind and solar energy for water pumping available only to contributors. Write: Compendium, TOOL Foundation, Mauritskade 61 a, Amsterdam.

In 1974, Windworks (Route 3, Box 44-A; Mukwonago, WI 53149 USA) designed a sail windmill which in terms of materials and fabrication processes stands somewhere between a Cretan design and an Aermotor. It uses a (salvage) automobile differential as its backbone, and the 'driveshaft' extends to the ground to provide rotary power.

While requiring welding, cutting, and drilling of metal, fabrication does not require forging, lathe work, or galvanizing. The octahedron module tower uses 40% less steel than traditional angle iron designs while providing the same strength, and a wood tower can be substituted. With its 25' diameter rotor, oil bath gears, oversized ball bearings, and primarily steel construction, this design is capable of 4-6 hp of work for many years.

Brace Research Institute (Ste. Anne-de-Bellevue 800; Quebec, Canada) built a second generation of this design to gain experience with it and review the 15 page set of detailed blueprints and the 22 page construction manual which are now available through Brace.



## Arusha

In 1974, Dick Stanley, a foreign development worker, undertook to design a windmill which could be built with local skills and materials in Arusha, Tanzania. The result is the Arusha design which is now manufactured and sold by a local co-operative, UJUZI LEO INDUSTRIES: P.O. box 764, Arusha, Tanzania.

New Scientist, 14 September 1978: (The windmill) ...is so simple that anyone can make it, and if someone with more skill and experience opened up in competition, 'they could over-run the co-op tomorrow. I've lost a lot of sleep over this,' Stanley admits.

In 1975, Rockwell International was mandated by the U.S. Dept. of Energy to build a small wind electric industry. Several small wind businesses were funded in hopes they could survive with the major corporations in the field. Same goal as Stanley, different motivation, should be an interesting set of experiments.

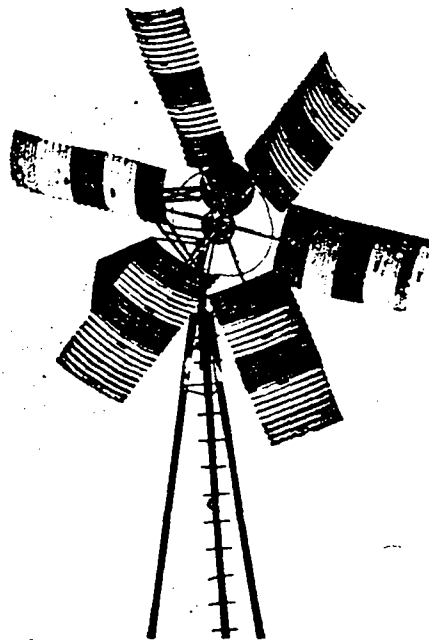

THE ARUSHA WINDMILL:  
A CONSTRUCTION MANUAL  
is available from VITA,  
3706 Rhode Island Ave.;  
Mt. Rainier, MY 20800  
USA for \$3.75 postpaid.

### DESCRIPTION AND SPECIFICATIONS

An entirely locally made water dumping windmill with future options to provide grain grinding and other low-speed rotary power applications.

- 18' 6" diameter rotor, horizontal axis, high solidity, low speed design
- uses six light-weight corrugated metal blades
- uses an eccentric wheel rocker arm as a drive mechanism
- total weight of fan and tail: 270 lbs. total approximate overall weight: 800 lbs.
- can develop 3 shaft hp in a 15 mph wind
- has a pumping rate of 600 gal/hr in a 12 mph wind with a 180' head and a 2" cylinder
- can pump at wind speeds as low as 6 mph
- cut-out speed of 20 mph
- can pump from depths as great as 250'

### FEATURES

- self-governing by use of a cambered pivoting tail vane
- adjustable pump stroke
- one motion pull out/break mechanism which unloads wind stresses before engaging handbrake
- metal pipe pivoting tower allows easy field installation with ground assembly of the major components
- easily installed in a two day period
- all moving parts are either in sealed bearings or equipped with machined, easily replaced bearings
- easily transported to site on a long chassis Lanchester equipped with a simple roof rack
- convertible to hand pump in periods of no wind

### COST AND SUPPLY

- un-assembled kit is available at \$15,000 (or US\$1925)
- field assembly and maintenance programs offered according to location
- compatible pump unit available at \$1500 (or US\$193)
- manufactured by:

The New Alchemy Institute (P.O. Box 432, Woods Hole, MA 02543 USA) sail-wing windmill is a downwind design. High speed governing is provided automatically with a spring-cable mechanism in the sails' trailing edges which allows unattended pumping. The backbone of the design is a salvage crankshaft from an automobile engine.

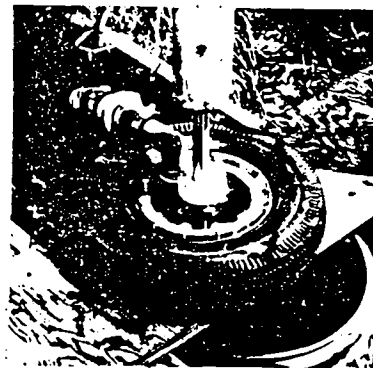
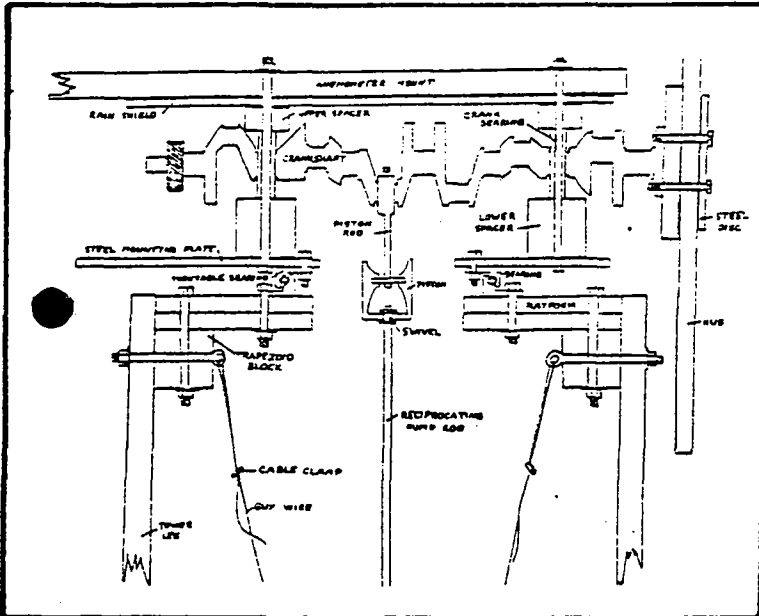
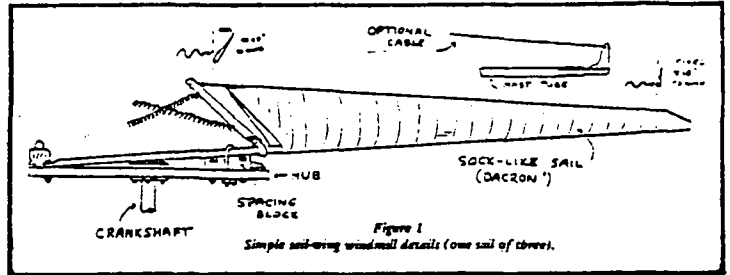

DIAPHRAGM PUMP

Build around a tire

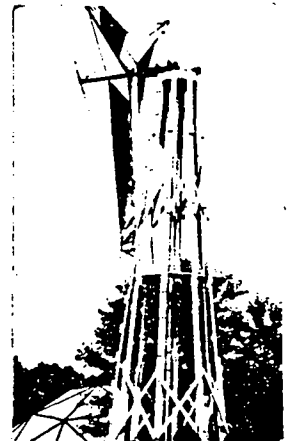

WOODEN TOWER

## ITDG

### INITIAL PREPARATION.

Saw timber into shape of an oblong block somewhat larger than the O.D of the finished bearing to allow for shrinkage and bore being off centre. Bore hole through centre of block the size of the journal.

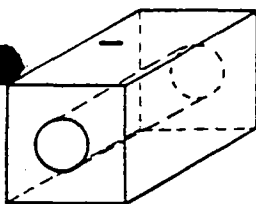

### DEHYDRATION

Soon after submerging the bearing blocks in hot ground-mit oil, many surface bubbles 1" in diameter, made from a multitude of smaller bubbles, will appear on the surface.

As the moisture content of blocks is reduced, the surface bubbles will become smaller in size.

When the surface bubbles are formed from single streams of pin-size bubbles, the dehydration process has gone far enough. Stop heating, and let blocks cool in the oil overnight.

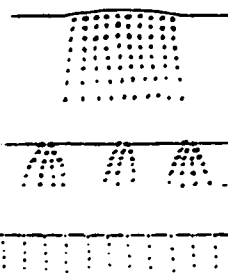
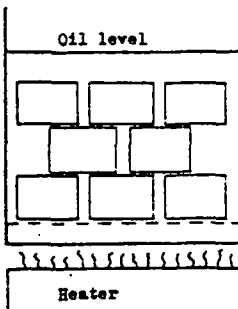

Intermediate Technology Development Group, founded by E.F. Schumacher in 1965, has since led the way in introducing a broad range of technologies which can be built with local materials and skills to the Third World. They offer a wide range of publications and a quarterly journal, Appropriate Technology (\$10 US, £4). North Americans write: International Scholarly Book Service, Inc.; P.O. Box 555, Forest Grove, OR 97116 USA; everyone else write: Intermediate Technology Publications LTD., 9 King Street; London WC2E 8HN United Kingdom.

From: "Oil Soaked Wood Bearings", Appropriate Technology, Vol. 2:4.

# SAVONIUS ROTORS

The Savonius rotor was invented by Captain Sigurd Savonius, a Finn, in 1924. He developed and marketed the rotor primarily as a water pumping windmill.

Savonius rotors never seriously challenged Aermotor-type windmills due to their higher cost. However, their vertical axis design and the fact they can be easily fabricated from oil drums which are widely available at reasonable cost in developing areas makes the rotor a possible option when undertaking the local fabrication of water pumping windmills.

Typically, the rotor would be compared with a horizontal axis windmill such as a Cretan sail windmill. Two design parameters help distinguish which windmill is best suited to an application. First, and most important, is the amount of water required. The Savonius is a low yeild machine due to its small swept area and is capable of pumping 100-200 gallons (US) per hour against a 10' head in an 8-12 mph mean wind. This amount of water is quite sufficient for domestic supplies for several families but is not enough for irrigation in most cases. Second, where oil drums are available and inexpensive, the Savonius can be easily fabricated at a low cost. Wood bearings may be used, and assembly requires cutting, fasteners, and plumbing pipe.

Savonius' have been criticized for not pumping as much water as sail windmills, for example in Food from Windmills. Again, they have a much smaller area exposed to the wind than a sail windmill and their application is limited to low demand situations.

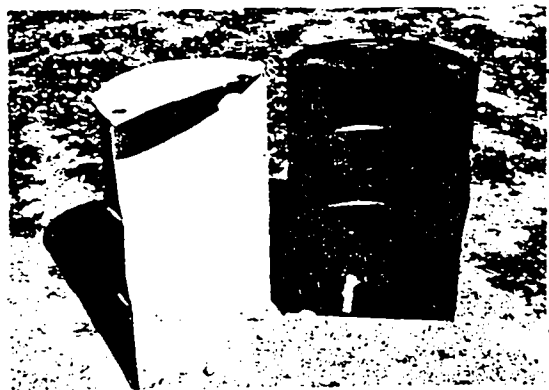

55 GALLON OIL DRUM

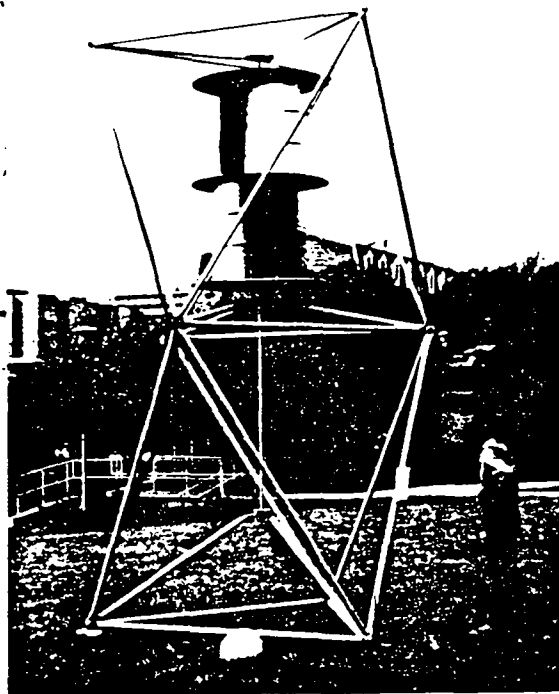

SAVONIUS ROTOR IN OCTAHEDRON MODULE TOWER

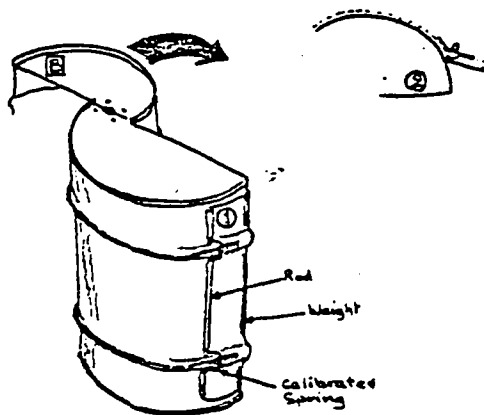
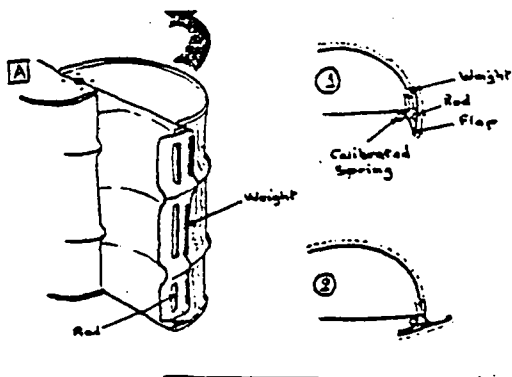

SPEED LIMITATION DEVICE

Eric Brunet, 1975

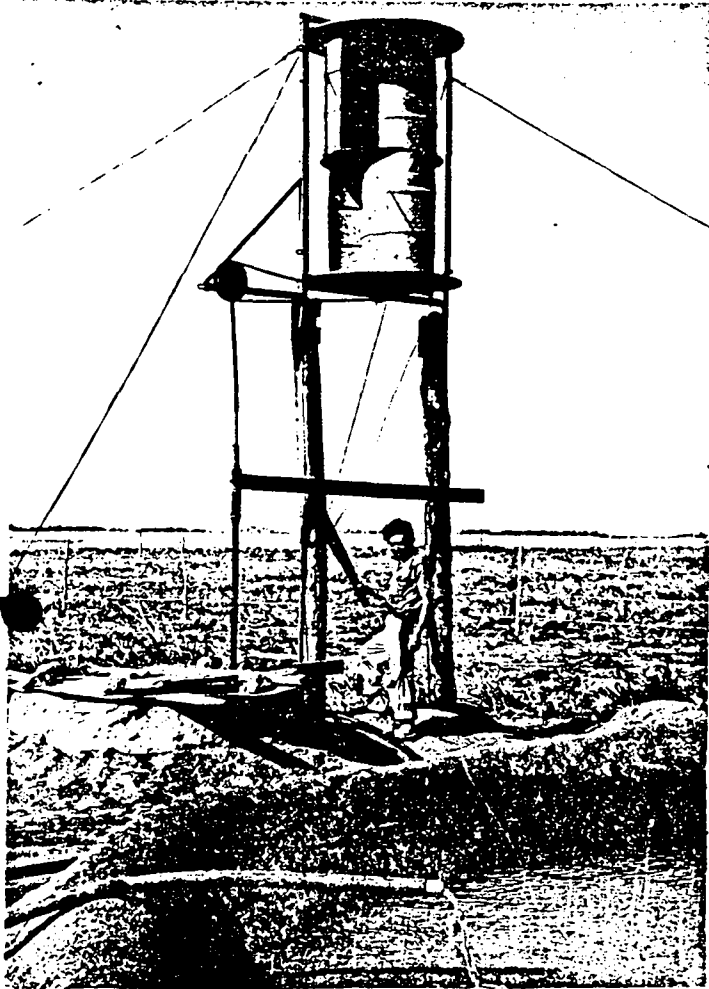

META REGION, COLOMBIA

This Savonius rotor provides water for approximately 100 beef cattle, and domestic water for a family of five.

This is one of several rotors built in this region of Colombia since 1971 under the direction of Dr. James Spain (Rockefeller Foundation, 1133 Avenue of the Americas, NY, NY 10036 USA) working with the Beef Production Team of Centro Internacional de Agricultura Tropical of Cali, Colombia.

Traditionally, water for cattle in this region has been provided by numerous streams. However, Dr. Spain writes, "The cattle get mired down in mud holes attempting to get to water in streams and the older, lactating cows are rarely able to recover from spending more than just a few hours in a mud hole. Therefore, losses are very high, and a windmill

could easily be paid for in a single season. Conventional windmills were manufactured in Colombia...but quality control was poor and people have very little confidence in this type of solution to the water problem."

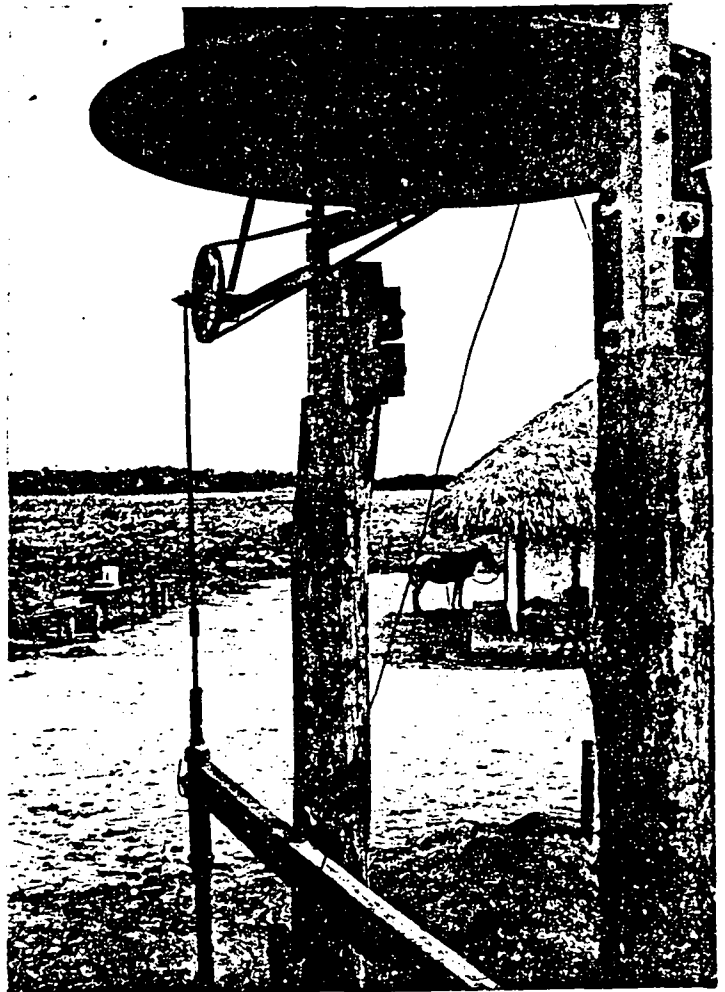

This design uses a V-belt drive to step rotor speed down 1/3 and drive a positive displacement pump (2" piston). The pulley to the left of the rotor and above provides eccentricity for the pump. This pulley is drilled so that the pump stroke can be varied from 5-20 cm to adjust for a seasonal variation in water depth of 2-13 meters.

Dr. Spain estimates the machine pumps 1 liter per second from 6 meters and 1/2 to 2/3 liters per second (475-625 gallons us per hour) from 8 meters, both in an estimated 12 mph wind.



The Brace Research Institute (Ste.-Anne-de-Bellevue 800; Quebec, Canada) was founded in 1961 with the mandate to develop water resources in developing countries. Since then, they have provided numerous publications concerning wind energy, solar distillation and crop drying, and other technologies related to developing water resources.

They built a 33' diameter windmill water pump for irrigation in Barbadoes in the late 1960's. This machine used a truck differential as its backbone and the fiberglass blades used were the result of one of the most thorough aeroelastic analyses performed at that time.

Their booklet, "How to Construct a Cheap Water Pumping Windmill" (1964) provides a detailed set of instructions for fabricating a Savonius rotor. However, this design requires unnecessary welding and machine work which could be unavailable in developing areas. Also, the Fafnir bearings specified are not designed for the axial loading of the rotor and will fail in less than two years.

## PERFORMANCE OF SAVONIUS ROTOR

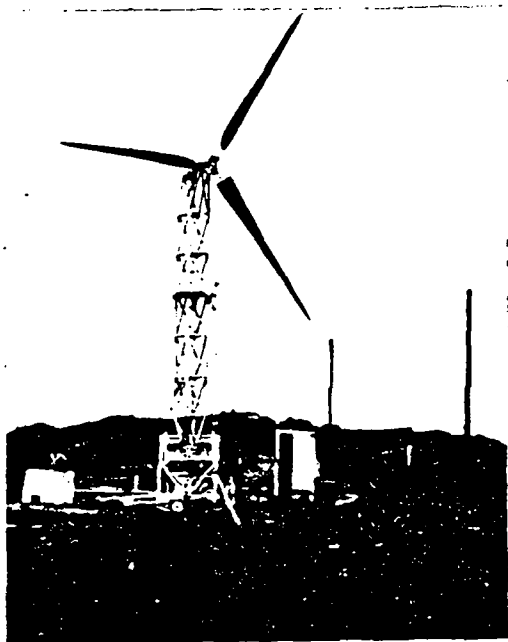
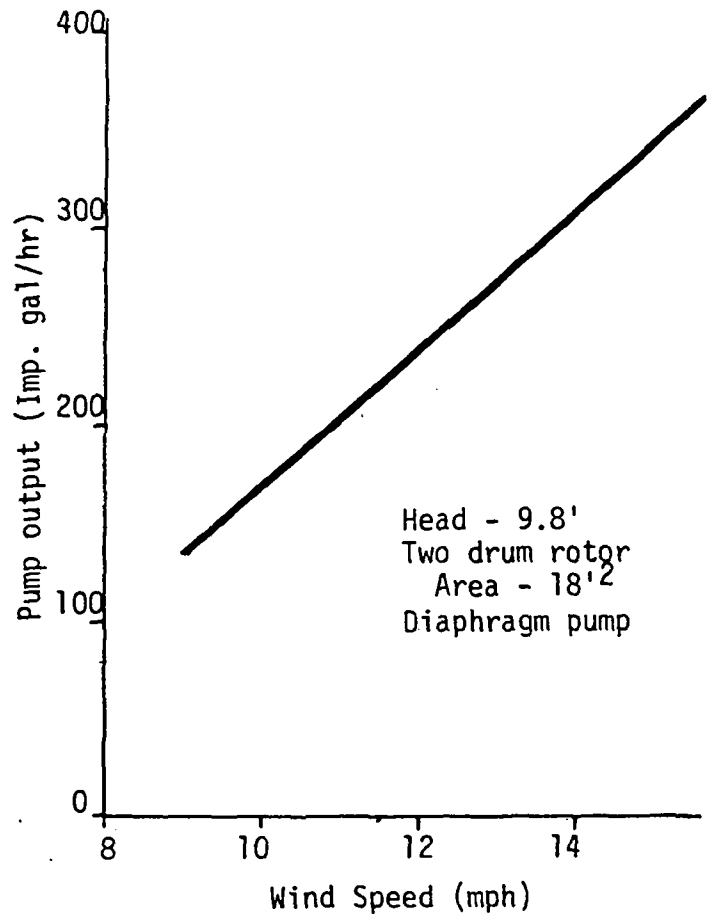

33' WINDMILL - ON BARBADOES

## POWER CHARACTERISTICS FOR RANGE OF WINDMILLS

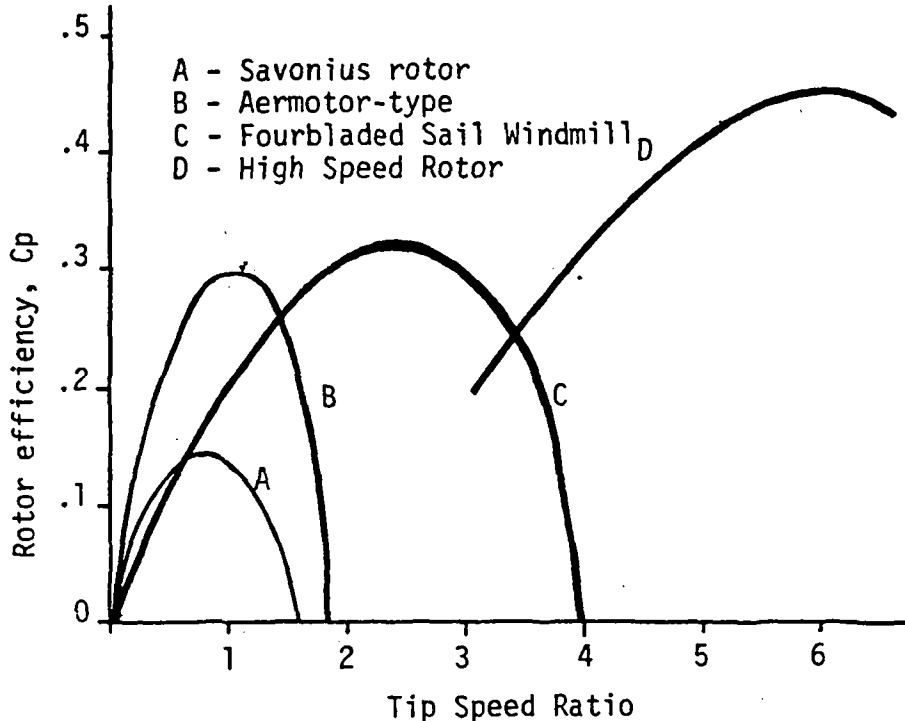

In 1975, the International Rice Research Institute (P.O. Box 933, Manila, Philippines) under the direction of Bart Duff, Agricultural Economist, began investigating Savonius rotors for rice irrigation.

Perhaps the most unique aspect of the work which has followed is the adaptation of a 'tubular' pump to the rotor. A suction pump, it is capable of lifting water 20', and with heads less than the length of a horizontal arm of the pump the pump does not need a foot valve and is self-priming. This pump allows the rotary motion of the Savonius' center shaft to be used directly, rather than changing this rotary motion to reciprocating motion for driving piston or diaphragm pumps. It also allows the use of standard plumbing pipe and couplings throughout the fabrication process, both for the central shaft of the Savonius and for the pump. This greatly simplifies the fabrication process and the locating of materials.

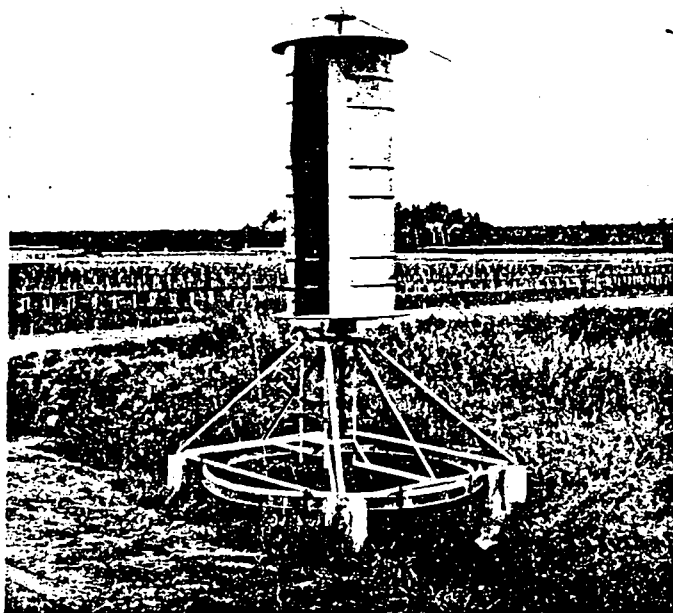

IRRI SAVONIUS ROTOR AND TUBULAR PUMP

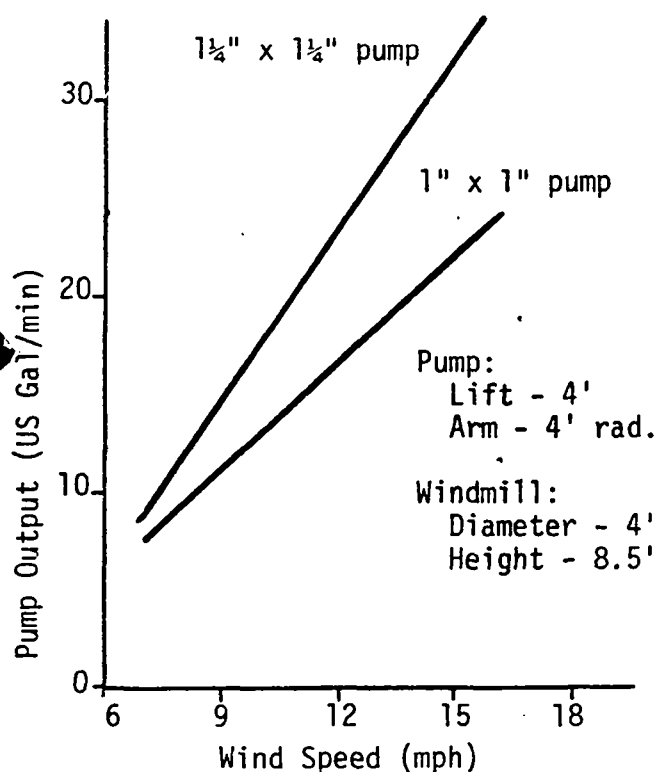

ESTIMATED PUMPING PERFORMANCE  
SAVONIUS ROTOR AND  
TUBULAR PUMP

from IRRI

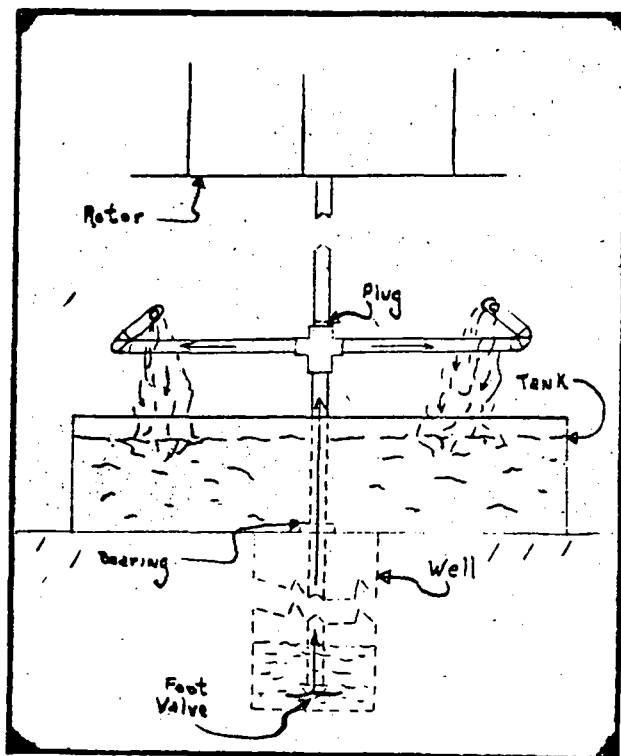

SCHEMATIC OF TUBULAR PUMP

## SAVONIUS ROTOR BIBLIOGRAPHY

- Ackeret, Dipl.-Ing. J., "Das Rotorschiff und seine physikalischen Grundlagen", published by Bandenhoeck and Rupert, Göttingen, Finland, 1925.
- \* Agrawal, Shyam Kumar, "Savonius Rotor As a Power Generator", Master's Thesis, Department of Mechanical Engineering, Queen's University, Kingston, Ontario, Canada, 1968, 83 pages.
  - \* Bach, G., "Investigations Concerning Savonius Rotors and Related Machines" 1931, 27 pages.
  - \* Blackwell, Ben F., "Wind Tunnel Performance Data for Two- and Three-Bucket Savonius Rotors", Sandia Laboratories, SAND76-0131, 1977, 107 pages; available from NTIS, 5285 Port Royal Road, Springfield, VA USA 22161 for \$5.50.
  - \* Blake, Steve, "Savonius Rotor Wind Turbines", Wind Power Digest, Vol. 1:6, Sept., 1976, 3 pages.
  - \* Bodek, A. and Simonds, M.H., "Performance Test of a Savonius Rotor", Brace Research Institute Technical Report No. T-10, 1964, 12 pages.
  - \* Carver, Charles E. and MacPherson, Russell B., "Experimental Investigations of the Use of A Savonius Rotor As A Power Generation Device", from the Proceedings of the University of Sherbrooke Conference on Wind Energy, University of Sherbrooke, Sherbrooke, Quebec, CAN, 1974, 19pps.
  - \* Gaul, R.D. and Snodgrass, J.M., "Some Dynamical Properties of the Savonius Rotor (Water) Current Meter", Marine Sciences Instrumentation, Volume 2, 1962; 11 pages.
  - \* Gaul, R.D., "The Savonius Rotor (Water) Current Meter", Technical Report 62-2T, Department of Oceanography and Meteorology, Agricultural and Mechanical College of Texas, Feb. 1962.
  - Gaul, R.D., "Evaluation of the Hytech Corporation (Water) Current Meter Calibration System", Hytech Corporation, San Diego, California USA, October, 1961, unpublished.
  - Hackleman, Michael A. and House, David W., Wind and Windspinners, Peace Press, Culver City, California, USA, \$7.50.
  - \* Kentfield, J.A.C., "A Modified Savonius Wind Turbine with Low Velocity-ratio Torque Characteristics", Faculty of Engineering, Dept. of Mech. Eng., Univ. of Calgary, Calgary, Alberta, CAN 19pp.
  - \* Klemm, A., "The Savonius Wind Rotor", Mechanical Engineering, Vol. 7:11, Nov. 1925, 2 pages.
  - \* Lek, Ah Chai, "Experimental Investigations of the Savonius Rotor", Dept. of Mech. Engin., McGill University, Montreal, Quebec, Canada, 1974. 82 pages.
  - \* MacPherson, Russell B., "Design, Development and Testing of a Low-head, High Efficiency Kinetic Energy Machine", Dept. of Civ. Eng., Univ. of Mass., Amherst, MA USA, 1972, 62 pages.
  - \* Mercier, John A., "Power Generating Characteristics of Savonius Rotors (in water)", Davidson Laboratory, Stevens Institute of Technology, Hoboken, NJ USA, 1966, 29 pages; available through NTIS, 5285 Port Royal Road, Springfield, VA USA 22161.
  - \* New York University, "The Savonius Rotor", College of Engineering, Engineering Research Division, New York, New York, circa 1942, 15 pages.
  - \* Power, "Flettner's Sailless Ship Explained", Vol. 60:27, December, 1924, 1 page.
  - \* Salazar, Godofredo C., "Improved Savonius Windmill", International Rice Research Institute, Agricultural Engineering Department, P.O. Box 933, Manila, Philippines, 1976, 9 pages.
  - \* Shankar, P.N., "The Effects of Geometry and Reynolds Number on Savonius Type Rotors", National Aeronautical Laboratory, AE-TM-3-76, Bangalore, India, February, 1976.
  - \* Smith, Bill and Lane, Mike, "The Savonius Rotor - A Study of the Effect of Geometric Variations on Performance in Natural Wind", Dept. of Mech. Eng., McGill University, Montreal, Quebec, Canada, April, 1975, 43 pages.
  - \* Savonius, Captain Sigurd J., "The Wing Rotor in Theory and Practice", A/B Nordblad and Petterson OY, Helsingfors, Finland, 1928, 22 pages.
  - \* Savonius, Captain Sigurd J., "The S-Rotor and Its Applications", Mechanical Engineering, Volume 53:5, May, 1931, 6 pages.

Articles marked (\*) may be obtained from:

Appropriate Technology Group  
Route 1, Box 93-A  
Oskaloosa, Kansas 66066 USA  
1-913-597-5603